



Q50 R Carbon

Directions for Use

  
**QUICKIE**<sup>®</sup>

This product complies with the standards set forth in EU and UK regulations. Options or accessories shown are available at extra cost.

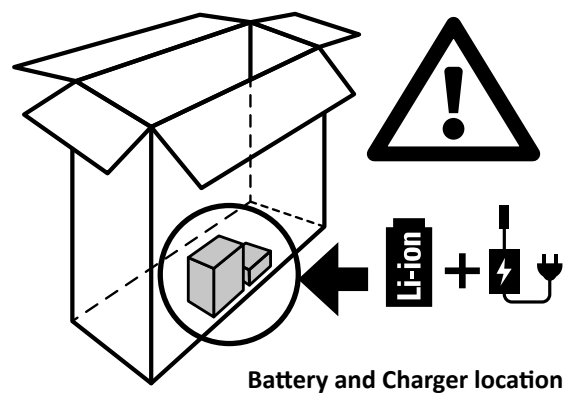

If you have any queries about the use, maintenance or safety of your wheelchair, please contact your local approved Sunrise Medical service agent. If you do not know of an approved dealer in your area or have any other questions please write or telephone:

**Sunrise Medical**  
**Thorns Road**  
**Brierley Hill**  
**West Midlands**  
**DY5 2LD**  
**England**  
**Phone: 0845 605 66 88**  
**Fax: 0845 605 66 89**  
**www.SunriseMedical.co.uk**

## Contents

<b>1.0 User information .....</b>	<b>4</b>
1.1 This user manual .....	4
1.2 For further information .....	4
1.3 Packaging .....	4
1.4 Symbols used in this manual .....	5
<b>2.0 Safety .....</b>	<b>6</b>
2.1 Symbols and labels used on the product .....	6
2.2 Safety: Temperature .....	6
2.3 Safety: Moving parts, (Fig.2.6) .....	7
2.4 Safety: Electromagnetic radiation .....	7
2.5 Electromagnetic interference (EMI) .....	8
2.6 Safety: Choking hazard .....	10
2.7 Safety: Using a (vehicle mounted) wheelchair lift .....	10
2.8 Safety: Lifting the wheelchair .....	10
<b>3.0 Intended use of the wheelchair .....</b>	<b>11</b>
3.1 Area of application: The user .....	11
3.2 Area of application: The user environment .....	12
<b>4.0 Setting up the wheelchair .....</b>	<b>13</b>
4.1 Assembling .....	13
4.2 Adjusting .....	14
4.3 Operating .....	14
4.4 Folding .....	15
4.5 Control system programme .....	15
4.6 Lap strap / seating positioning belt .....	16
<b>5.0 Using the wheelchair .....</b>	<b>17</b>
5.1 Checking wheelchair before use .....	17
5.2 Joystick .....	18
5.3 Making a transfer .....	18
5.4 Driving the wheelchair .....	19
5.5 Curves .....	19
5.6 Braking & Emergency stop .....	19
5.7 Driving on a slope .....	20
5.8 Obstacles & kerbs: .....	21
5.9 Pushing the wheelchair .....	22
<b>6.0 Batteries, charging and range .....</b>	<b>23</b>
6.1 Usage of Battery .....	23
6.2 Usage of Charger .....	23
6.3 Charging batteries: .....	24
6.4 The range of your vehicle: .....	25
6.5 Battery warranty: .....	26
6.6 Replacing batteries .....	26
6.7 Air Transportation of the wheelchair .....	26
6.8 Disconnecting batteries for air transport .....	27
6.9 Transportation in vehicles: .....	27
6.10 Special transport requirements .....	28
6.11 General transport warnings .....	28
<b>7.0 Fault analysis and troubleshooting .....</b>	<b>29</b>
<b>8.0 Maintenance &amp; cleaning .....</b>	<b>30</b>
8.1 Maintenance .....	30
8.2 Tyre maintenance and pressures .....	31
8.2.1 Tyre wear .....	31
8.2.2 Drive wheel repair .....	32
8.3 Wheels & tyres maintenance .....	33
8.4 Cleaning and disinfection .....	34
8.5 Medium to long term storage: .....	34
<b>9.0 Disposal .....</b>	<b>35</b>
<b>10.0 Trouble shooting .....</b>	<b>36</b>
<b>11.0 Technical specifications:</b>	
<b>Applicable norms / standards .....</b>	<b>36</b>
<b>12.0 Warranty .....</b>	<b>38</b>
<b>13.0 Nameplate .....</b>	<b>39</b>

Dealer signature and stamp

## 1.0 User information

Thank you for purchasing your wheelchair from Sunrise Medical. As a part of ongoing product improvement initiatives, your product may change without notice. However, any changes to information provided for existing users shall be clearly communicated if they are safety critical. Further, not all features and options offered are compatible with all configurations of the wheelchair. All dimensions are approximate and may be subject to change. The intended lifetime of this product is 5 years. Please DO NOT use or fit any 3rd party components to the wheelchair unless they are officially approved.

### 1.1 This user manual

This user manual will help you to use and maintain your wheelchair safely.

### **Do not use your wheelchair until this entire manual and all relevant booklets have been read and understood!**

If one of the user manuals was not included with your wheelchair, please contact your dealer immediately.

### 1.2 For further information

Please contact your local, authorized Sunrise Medical dealer if you have any questions regarding the use, maintenance or safety of your wheelchair. In case there is no authorized dealer in your area or you have any questions, contact Sunrise Medical either in writing or by telephone.

### 1.3 Packaging

For air transport approval for your wheelchair, you must retain the original product packaging that your wheelchair is supplied with. It will be necessary to repack your wheelchair in the original box to comply with the air travel certification.

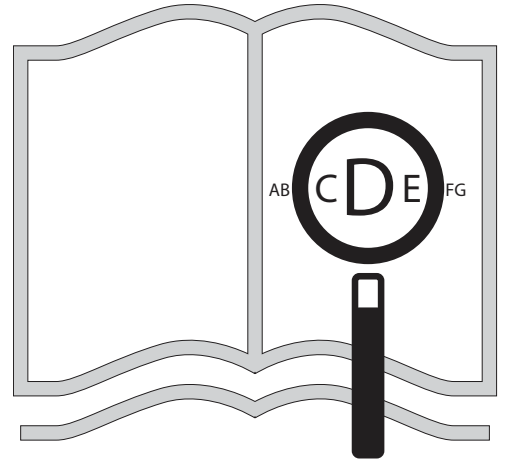

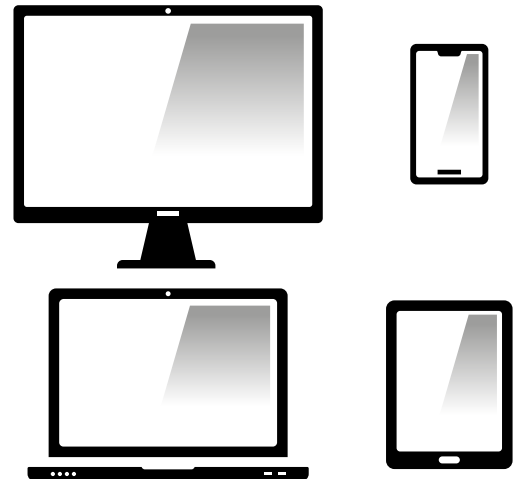

If you are visually impaired, this document can be viewed in PDF format at [www.SunriseMedical.co.uk](http://www.SunriseMedical.co.uk)





or alternatively is available on request in large text.



## 1.4 Symbols used in this manual

 <b>DANGER!</b>	Potential risk of injury or serious injury or death
 <b>WARNING!</b>	Potential risk of injury
 <b>CAUTION!</b>	Potential damage to equipment

 As the Authorised Representative, SUNGO EUROPE B.V., declares that this product conforms to the Medical Device Regulation (2017/745).

 As the Authorised Representative, SUNGO CERTIFICATION COMPANY LIMITED, declares that the product conforms to the UK Medical Devices Regulation 2002 No. 618.

### NOTE:

#### General user advice.

Not following these instructions may result in physical injury, damage to the product or damage to the environment!

Notice to the user and/or patient: Any serious incident that has occurred in relation to the device should be reported to the manufacturer and the competent authority of the Member State in which the user and/or patient is established.

### B4Me special adaptations

Sunrise Medical strongly recommends that in order to ensure that your B4Me product operates, and performs as intended by the manufacturer; all the user information supplied with your B4Me product is read and understood, before the product is first used.

We also recommend that the user information is not discarded after reading it, but it is kept safely stored for future reference.

### Medical Device Combinations

It may be possible to combine this Medical device with one or more other Medical Device or other product. All combinations listed have been validated to meet the General Safety and Performance Requirements, Annex I Nr. 14.1 of the Medical Device Regulation 2017/745.

## 2.0 Safety

Follow the instructions carefully next to these warning symbols! Not paying careful attention to these instructions could result in physical injury or damage to the wheelchair or the environment. Wherever possible, safety information is provided in the relevant chapter.

### 2.1 Symbols and labels used on the product

The signs, symbols and instructions affixed to the wheelchair comprise part of the safety facilities. They must never be covered or removed. They must remain present and clearly legible throughout the entire lifespan of the wheelchair.

Replace or repair all illegible or damaged signs, symbols and instructions immediately. Please contact your dealer for assistance.

Fig. 2.1. Warning – Danger of finger entrapment

Fig. 2.2. Freewheel mechanism

Fig. 2.3. The serial number and information label, (example only).

Fig. 2.4. UK Responsible Person and EC REP label (example only).

Fig. 2.5. Location of Serial Number Label (*overleaf*)

### 2.2 Safety: Temperature

#### WARNING!

- Avoid physical contact with the wheelchair's motors at all times. Motors are continuously in motion during use and can reach high temperatures. After use, the motors will cool down slowly. Physical contact could cause burns. Allow the motors after using at least 30 min. to cool down.
- If you do not use the wheelchair, ensure that it is not exposed to direct sunlight for lengthy periods of time. Certain parts of the wheelchair, such as the seat, the back and the armrests can become hot if they have been exposed to full sunlight for too long. This may cause burns or allergic reactions to the skin.



Fig. 2.1

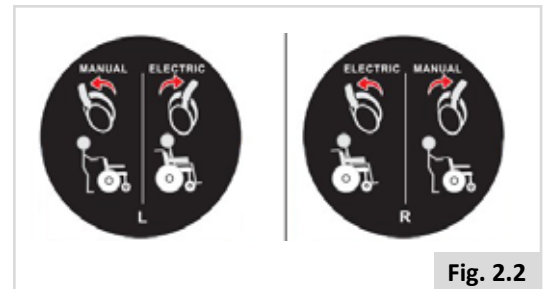

Fig. 2.2

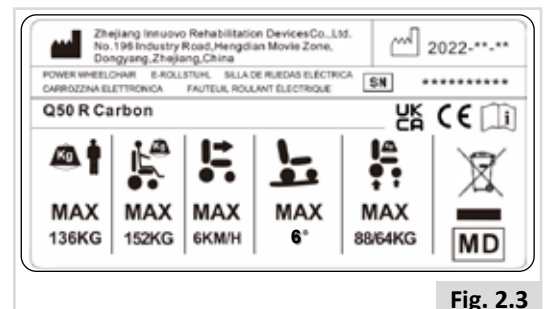

Fig. 2.3

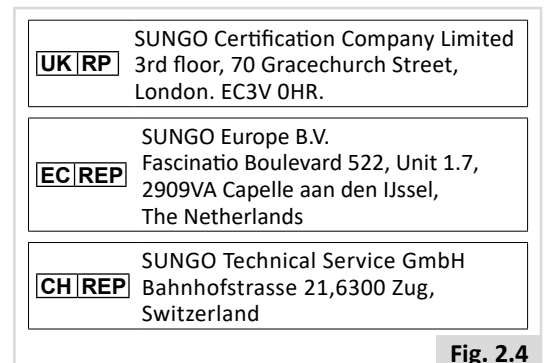

Fig. 2.4

### 2.3 Safety: Moving parts, (Fig.2.6)

#### **⚠ DANGER!**

A wheelchair has moving and rotating parts. Contact with moving parts may result in serious physical injury or damage to the wheelchair. Contact with the moving parts of the wheelchair should be avoided.

- Wheels (turning and castor)
- Backrest folding latch (Fig. 2.6)
- Swing-away bracket of the controller

### 2.4 Safety: Electromagnetic radiation

#### **⚠ CAUTION!**

The standard version of your electric wheelchair has been tested on the applicable requirements with respect to electromagnetic radiation (EMC requirements) In spite of these tests:

It cannot be excluded that electromagnetic radiation may have an influence on the wheelchair. For example:

- mobile telephony
- large-scale medical apparatus
- other sources of electromagnetic radiation
- It cannot be excluded that the wheelchair may interfere with electromagnetic fields. For example:
  - shop doors
  - burglar alarm systems in shops
  - garage door openers

In the unlikely event that such problems do occur, we request that you notify your dealer immediately.

#### **⚠ DANGER!**

- When operating two-way radio, walkie-talkies, C.B., Amateur radio, public mobile radio and other powerful transmitting devices the wheelchair should be brought to a halt and turned off.
- The operation of cordless, mobile telephones and cell phones including hands-free devices is permitted but if abnormal operation of the wheelchair is encountered then the chair must be brought immediately to a halt and turned off.

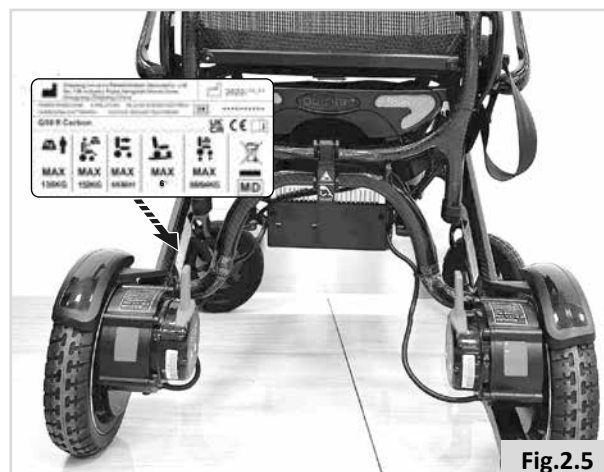

Fig.2.5

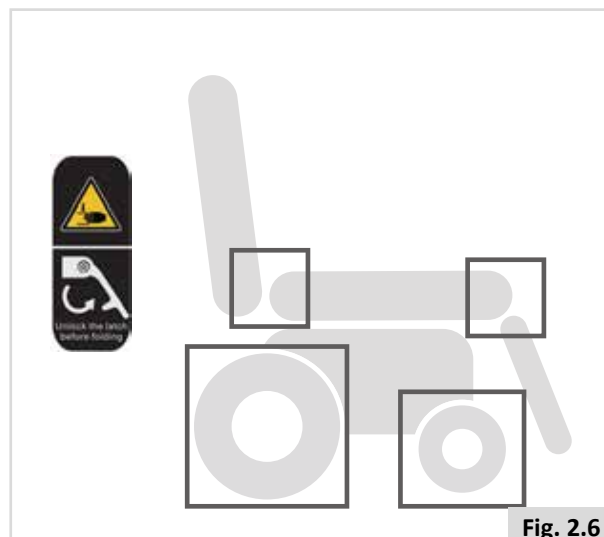

Fig. 2.6

## 2.5 Electromagnetic interference (EMI)



Electromagnetic interference is from external electromagnetic wave energy (like radios, TV transmission stations, CB radio waves, garage door starters, radio phones, etc.). Electromagnetic interference may affect the control system of the power wheelchair. Some interference may lead to the brake failure, power on automatically, or steering failure, also may lead to the permanent damages to the control systems. Below cables information are provided for EMC reference.

Cable	Max. cable length, shielded / unshielded		Number	Cable classification
AC Power Line	1m	Shielded	1 set	AC Power
DC Power Line	1m	Shielded	1 set	DC Power

- Important information regarding Electro Magnetic Compatibility (EMC)
- This electrical medical equipment needs special precautions regarding EMC and needs to be put into service according to the EMC information provided in the user manual; The equipment conforms to this IEC 60601-1-2:2014 standard for both immunity and emissions. Nevertheless, special precautions need to be observed:
- The equipment with ESSENTIAL PERFORMANCE, has been designed to be used to be in an indoors environment.

### ESSENTIAL PERFORMANCE:

- **WARNING:** Use of this equipment adjacent with other equipment should be avoided because it could result in improper operation. If such use is necessary, this equipment and the other equipment should be observed to verify that they are operating normally.
- The use of accessories, transducers and cables other than those specified or provided by the manufacturer of this equipment could result in increased electromagnetic emissions or decreased electromagnetic immunity of this equipment and result in improper operation.
- **WARNING:** Portable RF communications equipment (including peripherals such as antenna cables and external antennas) should be used no closer than 30 cm (12 inches) to any part of the Q50 R Carbon, including cables specified by the manufacturer. Otherwise, degradation of the performance of this equipment could result.
- **WARNING:** If the wheelchair is being used near (e.g. less than 1.5 km from) AM, FM or TV broadcast antennas, before using this equipment, it should be observed to verify that it is operating normally to assure that the equipment remains safe with regard to electromagnetic disturbances throughout the expected service life.
- When the AC input voltage is interrupted, the equipment will stop battery charging and if the power supply restored, it could be recovered automatically.

### EMI Compliance table (Table 1)

Table 1 - Emission

Phenomenon	Compliance	Electromagnetic environment
RF emissions	CISPR 11 Group 1, Class B	Home healthcare environment
Harmonic distortion	IEC 61000-3-2 Class A	Home healthcare environment
Voltage fluctuations and flicker	IEC 61000-3-3 Compliance	Home healthcare environment

### EMS Compliance table (Table 2 -5)

Table 2 - Enclosure Port

Phenomenon	Basic EMC standard	Immunity test levels Home healthcare environment
Electrostatic discharge	IEC 61000-4-2	±8 kV contact ±2kV, ±4kV, ±8kV, ±15kV air
Radiated RF EM field	IEC 61000-4-3	20V/m 26MHz-2.5GHz 80% AM at 1kHz 10V/m 80MHz-2.7GHz 80% AM at 1kHz
Proximity fields from RF wireless communications equipment	IEC 61000-4-3	Refer to table 3
Rated power frequency magnetic fields	IEC 61000-4-8	30 A/m 50 Hz or 60Hz



Table 3 – Proximity fields from RF wireless communications equipment

Test frequency (MHz)	Band (MHz)	Immunity test levels Home healthcare environment
385	380 - 390	Pulse modulation 18Hz, 27V/m
450	430 - 470	FM, $\pm 5$ kHz deviation, 1kHz sine, 28V/m
710	704 - 787	Pulse modulation 217Hz, 9V/m
745		
780		
810	800 - 960	Pulse modulation 18Hz, 28V/m
870		
930		
1720	1700 - 1990	Pulse modulation 217Hz, 28V/m
1845		
1970		
2450	2400 - 2570	Pulse modulation 217Hz, 28V/m
5240	5100 - 5800	Pulse modulation 217Hz, 9V/m
5500		
5785		

Table 4 - Input a.c. power Port

Phenomenon	Basic EMC standard	Immunity test levels Home healthcare environment
Electrical fast transients/burst	IEC 61000-4-4	$\pm 2$ kV 100kHz repetition frequency
Surges Line-to-line	IEC 61000-4-5	$\pm 0.5$ kV, $\pm 1$ kV
Conducted disturbances induced by RF fields	IEC 61000-4-6	0% UT; 0.5 cycle At 0°, 45°, 90°, 135°, 180°, 225°, 270° and 315°
		0% UT; 1 cycle and 70% UT; 25/30 cycles Single phase: at 0°
Voltage interruptions	IEC 61000-4-11	0% UT; 250/300 cycles UT=rated input voltage

Table 5 - Signal input/output parts Port

Phenomenon	Compliance	Electromagnetic environment
Electrostatic Discharge	IEC 61000-4-2	$\pm 8$ kV contact $\pm 2$ kV, $\pm 4$ kV, $\pm 8$ kV, $\pm 15$ kV air

## 2.6 Safety: Choking hazard



This mobility aid uses small parts which under certain circumstances may present a choking hazard to young children.

## 2.7 Safety: Using a (vehicle mounted) wheelchair lift

Wheelchair lifts are used in vans, buses and buildings to help you move from one level to another.



- Ensure that the user and all carers fully understand the lift manufacturer's instructions for using the passenger lift.
- Never exceed the lift manufacturer's recommended safe working load and load distribution guidance.
- Always turn off all power when you are on the lift. If you fail to do so, you may touch the joystick by accident and cause your chair to drive off the platform. Be aware that a roll-stop at the end of the platform may not prevent this.
- Always position the user securely in the chair to help avoid falls while on the lift.
- Always ensure the chair is in drive mode when using passenger lift (wheels locked not in freewheel mode).

## 2.8 Safety: Lifting the wheelchair



- Do not lift this seating system by any parts that are removable, doing so may result in damage to the seating system or injury to the user.

### 3.0 Intended use of the wheelchair

#### General description

The Q50 R Carbon is a power wheelchair. The design allows you to have an ideal driving experience indoors as well as outdoors. Due to its design and simplicity, the Quickie Q50 R Carbon is a perfect choice for easy service, refurbishment and recycle requirements.

The Q50 R Carbon series fulfils individual preferences, needs or circumstances and is available in the following configurations:

- Rear wheel drive (RWD): Q50 R Carbon

#### 3.1 Area of application: The user

Power wheelchairs are exclusively for a user who is unable to walk or has limited mobility, for their own personal use indoors and outdoors. Driving a powered wheelchair requires cognitive, physical and visual skills. The user must be able to estimate and correct the results of actions when operating the wheelchair.

The wheelchair cannot transport more than 1 person at a time. The maximum weight limit (includes both the user and any weight of accessories fitted to the wheelchair) is marked on the serial number label, which is affixed to the chassis of the chair (Fig. 2.9).

The user must be informed of the contents of this user manual before driving the wheelchair. In addition, the user of the wheelchair must be given thorough instruction by a qualified specialist before he or she participates in traffic. The first sessions in the wheelchair should be practiced under supervision of a trainer/advisor.

#### Indications

The Q50 R Carbon can be used by those who cannot walk or have limited mobility because of:

- Paralysis
- Loss of extremity (leg amputation)
- Extremity defect/deformity
- Joint contractures/joint injuries
- Illnesses such as heart and circulation deficiencies, disturbance of equilibrium or cachexia as well as for elderly people who still have strength in the upper body.

#### Contraindications

The wheelchair shall not be used in case of:

- Perception disorder
- Imbalance
- Seating disability

Fig. 3.1



Please note that driving a wheelchair requires sufficient cognitive, physical and visual skills. The user must be able to assess the effects of actions during the operation of the wheelchair and, if necessary, to correct them. These capabilities and the safe use of the additionally attached components cannot be assessed by Sunrise Medical. The manufacturer cannot accept any liability for any damage resulting from this.

Please refer to the operating instructions of the wheelchair and the additionally mounted components. Instruct the user in the safe use of the wheelchair and the additionally mounted components. Inform users of specific warnings that need to be read, understood, and respected.

#### Basic Components (Fig.3.1).

- |                |                 |
|----------------|-----------------|
| 1. Push handle | 7. Seat cushion |
| 2. Joystick    | 8. Battery box  |
| 3. Armrest     | 9. Foot rest    |
| 4. Frame       |                 |
| 5. Drive wheel |                 |
| 6. Back rest   |                 |

**⚠ WARNING!**

- If you are under the influence of medicines that can have an effect on your ability to drive, you are not permitted to drive a wheelchair.
- Adequate vision is required in order to safely operate a wheelchair in the user situation concerned.
- Not more than one person at a time can be seated in the wheelchair.
- Do not allow children to ride in the wheelchair unsupervised.

**⚠ CAUTION!**

- The user of the wheelchair is at all times completely responsible for complying with the applicable local safety regulations and guidelines.

**3.2 Area of application: The user environment**

This wheelchair has been designed for indoor use (EN12184 (2014) Class A). If driving the wheelchair outdoors, drive only on paved roads, pavements, footpaths and bicycle paths. The speed must be adapted to suit the environment.

**⚠ WARNING!**

- Drive carefully on slippery roads resulting from rain.
- When driving at higher speeds you must be extra careful. Select a lower maximum speed indoors, on the pavement and in pedestrian areas.
- Do not drive off high obstacles.
- Do not attach a weight to the wheelchair without the approval of a qualified specialist. This may negatively affect the stability of the product.

**⚠ CAUTION!**

- Prevent the wheelchair from coming into contact with sea water: sea water is caustic and may damage the wheelchair.
- Prevent the wheelchair from coming into contact with sand: sand can permeate into the moving parts of the wheelchair, causing extensive wear on these parts.
- Do not use the wheelchair if temperatures are below:  $-25^{\circ}\text{C}$  or above  $+50^{\circ}\text{C}$ .
- Do not open doors using the footrest.
- Do not push and/or tow any objects with the wheelchair.
- Do not drive through puddles of water.

(Please refer to Fig 3.2)

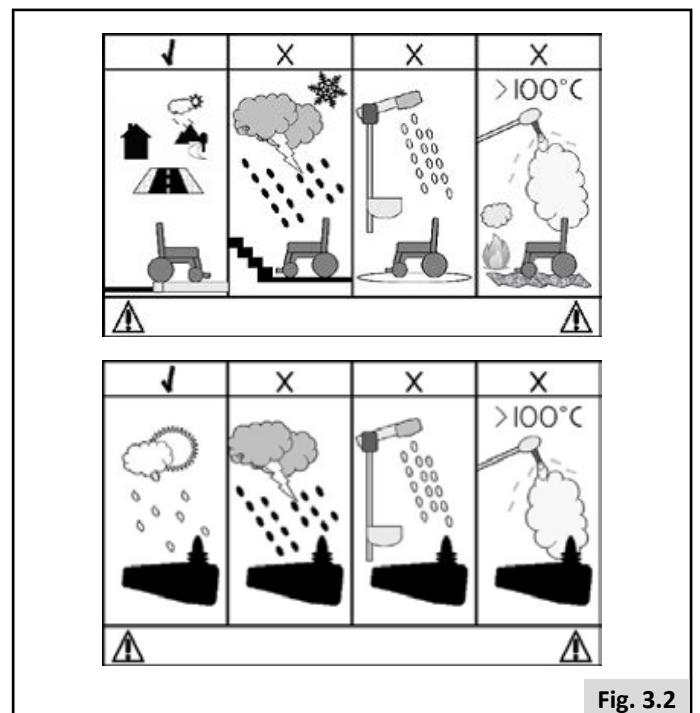

Fig. 3.2

## 4.0 Setting up the wheelchair

### 4.1 Assembling

Open the packaging box, take out the wheelchair and remove the protective padding. Firstly open the footrest, take out the battery and insert it fully into the battery rail. When you hear a “click”, this indicates the battery is installed in place (Fig. 4.1 - 4.2). Release Velcro strap wrapped around push handle (Fig.4.3 - 4.4). Then with one hand on the seat cushion and one on the backrest, unfold the wheelchair. (Fig. 4.5 - 4.6). When you hear another “click”, it indicates that the latch has fixed onto the locking pin (Fig. 4.7), and the wheelchair has been unfolded.

#### WARNING!

When inserting the battery, make sure that the battery clip has clicked into place to prevent the battery falling out. If it is difficult to insert the fixing clip into the battery, you can pull the fixing clip open by hand, then insert the battery. Please make sure that the clip “clicks” into place.

#### WARNING!

After unfolding the wheelchair, please check the latch has located and secured the backrest locking pin (Fig. 4.7). Please only sit in the wheelchair once this has been fixed. Otherwise, it will damage the wheelchair and could cause personal injury.



Fig. 4.1



Fig. 4.2



Fig. 4.3



Fig. 4.4



Fig. 4.5



Fig. 4.6



Fig. 4.7

## 4.2 Adjusting

### 4.2.1 Joystick Installation and Adjusting

The joystick can be adjusted to the most comfortable position for the user. When adjusting it, please loosen the knob located on the armrest and then the joystick can be moved forwards or backwards to its desired position. When at the desired position, please tighten the joystick firmly. (Fig. 4.8).



Fig. 4.8

### 4.2.2 Anti-tip wheels

Anti-tip wheels are a safety device to prevent the wheelchair from tipping backwards when driving on a slope (Fig. 4.9). Please do not adjust these.



Fig. 4.9

### 4.2.3 Adjusting freewheel

There are a set of levers attached to the driving motors. When the lever is located at A, the wheelchair will be in drive mode, which can only be operated with power. When the lever is located at B, the wheelchair will be in freewheel mode, which can only be pushed by hand. (Fig. 4.10)

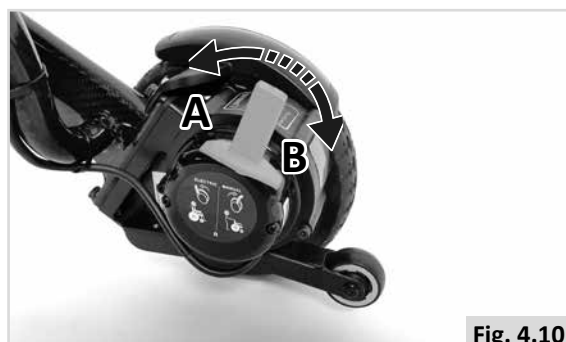

Fig. 4.10

### WARNING!

When the wheelchair is in manual mode, do not use your wheelchair unless getting help from your assistant. Otherwise, it may result in personal injury. Do not use your wheelchair in manual mode when it is on an incline. Otherwise, the wheelchair will roll down the slope and may cause personal injury.

### 4.2.4 Adjusting Armrests

For the convenience of getting on/off the wheelchair for people, the armrest can be flipped up. To flip up the armrest, just press the lock button under the armrest, whilst pushing the armrest up (Fig. 4.11). To push the armrest down, reverse this process.



Fig. 4.11

## 4.3 Operating

### 4.3.1 Preparation before operation

- Make sure that the wheelchair is in drive mode and only get in and out of the wheelchair when the power is off.
- Please fold out the footrest first then hold the armrest to sit on the wheelchair; Do not get off the wheelchair by stepping on the footrest. Otherwise this may cause personal injury.

### 4.3.2 Practice before operation

- Find a spacious place and have an assistant to help you practice until you have enough confidence to operate it.
- Be certain to shut down the power when you get on and off the chair.
- Set the speed control button to the speed you want.
- We recommend that you set the lowest speed setting until you can operate the electric wheelchair skillfully.
- Practice stopping, moving forward and backward. If you are assisting, make sure you are comfortable and confident with the operation of the wheelchair.

#### 4.4 Folding

When the wheelchair needs to be folded, please pull up the latch at the rear of the backrest whilst pushing the backrest forward (Fig. 4.12). Then with one hand on the seat cushion and one on the backrest, fold the wheelchair. With the wheelchair body folded in place, flip up the footrest, the wheelchair can be placed standing up (Fig. 4.13 - 4.16)

To keep the frame compact when lifting the wheelchair, apply the velcro strap and pull it tight so that the wheelchair doesn't collapse (Fig. 4.15).

#### 4.5 Control system programme

This wheelchair is equipped with a control system that can be programmed by adjusting settings within the system. This is a specialized job that needs training and can only be adjusted with professional software. The end user is not allowed to adjust these settings.

#### DANGER!

The incorrect setting of the parameters for the control system may result in injury. Settings must be made by qualified specialists.



Fig. 4.12



Fig. 4.13



Fig. 4.14



Fig. 4.15



Fig. 4.16

## 4.6 Lap strap / seating positioning belt

### DANGER! / WARNING!

- This product is only to be used to position a single person in a wheelchair.
- Lap straps are not suitable for transit purposes, approved occupant restraint systems must be used.
- Failure to heed these warnings may result in severe injury or death.
- Ensure that the carer or attendant is trained in the correct operation of the belts.
- Poorly fitted belts may lead to delays, if an emergency situation occurs.

### Positioning a person with a lapstrap

- Adjust the lap strap to suit, leaving no more than a hand's width gap for comfort and safety (Fig 4.17).
- The hand clearance should be with the lap strap under normal tension and not allow large gaps or loops.
- Generally, the lap strap should be fixed so that the straps sit at an angle of approximately 45° (Fig. 4.18), and when correctly adjusted should not allow user to slip down in the seat.
- Place the strap loosely across the seat with the opening end of the buckle facing to the right for a left-handed person and to the left for a right-handed person. Pass the other ends of the strap through the gap between the backrest posts and the backrest.

### DANGER! / WARNING!

- Always make sure that the lap strap is correctly secured and adjusted prior to use.
- If a strap is too loose it could cause the user to slip down and cause serious injury.
- Check lap strap and securing components at regular intervals for any signs of fray or damage. Replace if necessary.
- When servicing, check for correct operation of the release buckle and for any signs of wear on the material or plastic brackets.

### Regular Checks/Activities:

- As with all positioning components, there is a need for corrective adjustments as the person changes their seating position over time.
- Check the belts regularly for correct fitting, to ensure the safety and comfort of the user.

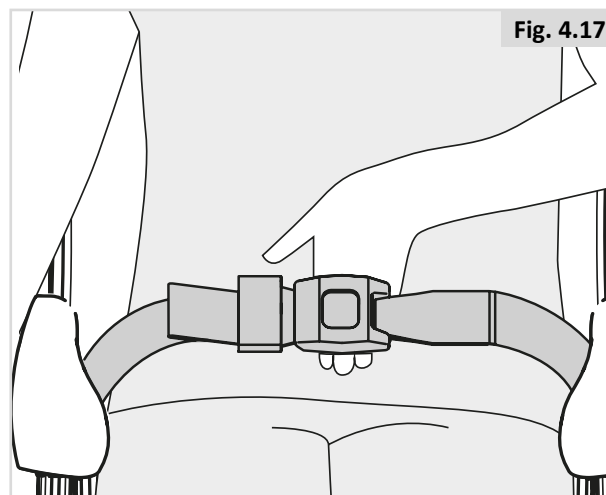

Fig. 4.17

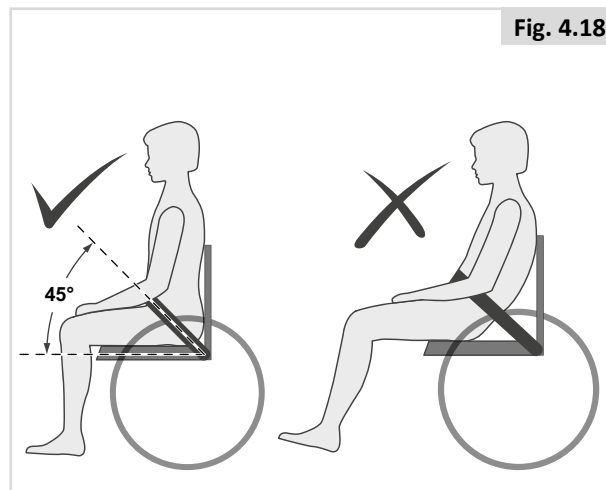

Fig. 4.18



## 5.0 Using the wheelchair

### DANGER!

- Be aware that you may need to adjust the controller settings of your system.
- Consult your authorised dealer to adjust the control settings immediately if you notice any change in your ability to:

1. Control the joystick
2. Hold your torso erect
3. Avoid running into objects.

### 5.1 Checking wheelchair before use

Perform the following daily check routine before driving:

### CAUTION!

#### Checking wheels

- Are the wheels sufficiently secured (Chapter 8.2).

#### Checking the battery

- Before using your vehicle for the very first time, please charge your battery for a period of 24 hours.
- Are the batteries sufficiently charged? The green lights on the battery indicator must be on.

#### Checking remote

- With the control system switched off, check that the joystick is not bent or damaged and that it returns to the centre when you push and release it.

#### Checking free wheel lever

- Ensure that the free wheel lever has been set to 'drive'.

#### Checking seating

- Ensure that all the cushions are in place.
- Visually inspect the wheelchair to make sure the leg rests, armrests etc. are correctly positioned and attached to the wheelchair and all fasteners are sufficiently tightened.

#### Checking clothing on potential entrapment

- When operating the wheelchair, ensure that your clothing does not hamper the wheelchair (i.e. too long). Before use, always check if your clothing or accessories do not come into contact with the wheels or and other moving and/or rotating parts in which they could become entangled.

#### Checking weather conditions

- In winter, batteries have a reduced capacity. During a period of light frost, the capacity is roughly 75% of the normal capacity. At temperatures below -5°C this will be roughly 50%. This will reduce your range of action.

### WARNING

Avoid wearing loose cuffs/sleeves when operating joystick as the joystick could get caught up.

### WARNING

If the foot plate rubs on the floor during use please be aware this may make the front edge sharp and therefore lead to injury. Therefore handle with care and replace the footrest if it becomes sharp.

## 5.2 Joystick

All the electronic components to control the wheelchair are integrated to the joystick (Fig. 5.1). The joystick is located on one of the armrests and is connected together to the power box with motors and battery.

- **Power Switch:** switches powerchair on and off. Do not stop the wheelchair driving by using the switch unless there is an emergency, otherwise it will shorten the life of the wheelchair drive components.
- **Joystick Lever:** The main function of the joystick is to control the direction and speed of the wheelchair. The joystick is pushed from its central position. When it is released, it will automatically reset and decelerate.
- **Horn Button:** Press this button, the horn will sound.
- **Speed increase Button and Speed decrease Button:** After turning on the power, the speed indicator displays the current maximum driving speed, and will increase or decrease by one bar with each press on the speed increase button or speed decrease button. The quantity of displayed bars represents the current maximum speed.
- **Charger Socket:** This socket can be used only for wheelchair charging (Fig. 5.2) Do not use the socket to supply power to any other electrical device. Otherwise, it may damage the wheelchair's control system or its E.M.C (electromagnetic compatibility) performance.

## 5.3 Making a transfer

Sunrise Medical recommend that you consult your healthcare professional for assistance in developing your personal front or side transfer technique to best suit your needs and avoid any personal injury.

### Preparing for a forward transfer:



**DANGER!**

It is dangerous to transfer on your own. It requires good balance and agility. Be aware that there is a point during every transfer when the seating system seat is not below you.

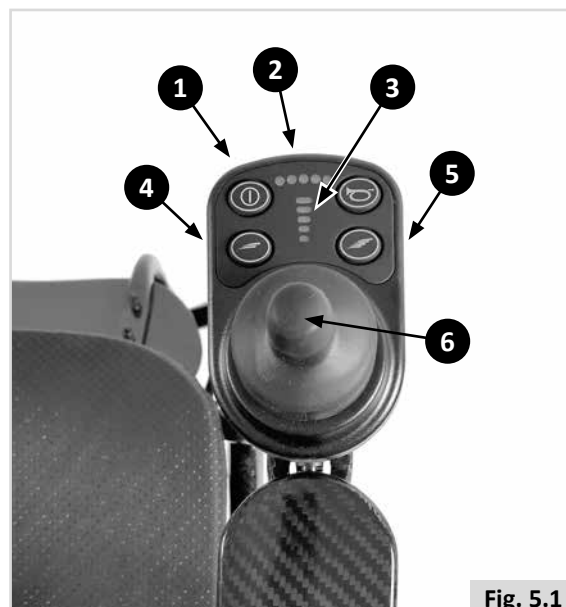

Fig. 5.1

### Joystick Components (Fig.5.1).

1. Power switch
2. Battery indicator
3. Speed indicator
4. Speed decrease button
5. Speed increase button
6. Joystick lever



Fig. 5.2

## 5.4 Driving the wheelchair

### WARNING

- The user of the wheelchair is at all times completely responsible for complying with the applicable local safety regulations and guidelines.

Powered wheelchairs are driven by means of a controller.

1. Switch on the controller.
2. Set the maximum speed limit.
3. Move the joystick in the direction in which you would like to go.
4. Moving the joystick even further forwards will cause the wheelchair to drive faster.

### Road use

This product is approved for indoor use. Please show the utmost consideration for the other traffic on the road if used outdoors.

### DANGER!

- Remember that the last thing a car or lorry driver expects to see is a wheelchair backing off the kerb into the road.
- If in any doubt, do not risk crossing the road until you are certain that it is safe.
- Always cross the road as quickly as possible, there may be other traffic.
- Ensure that there are no objects in your path that could possibly become lodged in your chair mechanism or in the spokes of the rear wheels. This could cause the chair to come to a sudden stop.
- Riding over drains or grids could cause the wheelchair castors or wheels to become lodged, causing the chair to come to a sudden stop.

### Adverse conditions:

Please be aware that when driving your wheelchair in adverse conditions, e.g. on wet slippery surfaces, you may experience a reduction in the grip and traction of your wheelchair.

### DANGER!

- We recommend you take extra precautions in these conditions, particularly on slopes; your wheelchair could become unstable or skid causing possible injury. This product is approved for indoor use.
- When you are using a Powered Wheelchair take extra care with loose or long items of clothing. Moving parts, such as wheels, can be potentially dangerous or even fatal if clothing becomes entangled.

### NOTE :

Extreme variances in temperature may trigger the self protect mechanism in the control system. If this occurs the control system will temporarily shut down to prevent damage to the electronics or the wheelchair.

## 5.5 Curves

### DANGER!

Full speed turns should not be attempted. If you need to turn sharply you must reduce your speed with the joystick or speed setting. This is particularly important when travelling across or down a slope. Disregarding this advice could lead to your wheelchair tipping over.

## 5.6 Braking & Emergency stop

There are three ways to stop your wheelchair:

- Simplest and safest way to stop the wheelchair is to release the joystick. This will bring the chair to a halt in a controlled manner.
- Pulling back the joystick will break the chair abruptly with a fast stop.
- Switching the control system off whilst the chair is in motion will also bring the chair to a halt.

### WARNING!

- Switching the control system off is only to be used in an emergency situation as the stopping action is very abrupt.

## 5.7 Driving on a slope

Your wheelchair has been designed and tested to allow its use on slopes or gradients of 6°.

Q50 R Carbon: 6° (10.5%) in standard configuration.

### DANGER!

- Stopping distances on slopes can be significantly longer than on level ground.

### DANGER!

- In certain circumstances your wheelchair could become unstable.
- Before attempting to climb or descend a slope or a kerb, caution should be taken when using your body for a counter balance weight.
- To improve stability lean forward when driving uphill, with the seat and back in an upright position.
- Alternatively sit in an upright position when travelling in a forward, downhill direction or recline the seat backwards.
- If you are in any doubt about the capabilities of your wheelchair on a slope then do not attempt to drive up or down the slope/kerb; try to find an alternative route.

## Gradients: ascents:

### WARNING!

- When going uphill, keep the chair moving.
- Steer by carefully moving the joystick forwards making slight Left and Right adjustments as you go.
- If you have stopped on a hill, you should start slowly.
- If necessary lean forward.

## Gradients: descents:

On descents, it is important not to let the wheelchair accelerate beyond its normal level of ground speed.

### DANGER!

- Proceed slowly down steep descents, (below the speed of 5kph) and stop if you feel anxious.
- If the chair picks up speed, centre the joystick to its home position to allow it to slow, or to stop.
- Restart slowly and do not allow the speed to increase above what you are comfortable with.

## NOTE:

- The controller has the benefit of a logic system that will help compensate when driving along a camber or up a hill. This is an added safety feature on your wheelchair. In addition of course, you may control the wheelchair speed by using the speed control.

## 5.8 Obstacles & kerbs:

### DANGER!

- Never descend a kerb backwards.
- Do not attempt to climb or descend a series of steps or use on escalators. It is unsafe to do so and could cause personal injury or damage the chair. This wheelchair has only been designed to climb a single step or kerb.
- We recommend that users with upper trunk instability wear restraint systems to keep the upright body position during descending or ascending ramps, kerbs or obstacles.

### **Kerb climbing:**

Always approach a kerb at 90° (Fig. 5.3).

- Approach the kerb or step, head on at a 90° angle.
- Drive forwards slowly and steadily.
- Stop the chair as soon as the castor wheels touch the kerb.
- Apply sufficient power to the motors to lift the front of the chair up onto the kerb or step and then apply slightly more power until the drive wheels climb the kerb or step smoothly.
- As far as possible, keep the joystick in the straight forward position.

The maximum obstacle or kerb climbing height is:

- Q50 R Carbon: 40 mm.

The approach speed and process can vary depending on your wheelchair drive type and castor wheel choice.

## Dismounting the kerb.

### DANGER!

Move the chair slowly and carefully in a forward direction until both front wheels are on the edge of the kerb, again in a 90° position to the kerb.

Drive as slowly as possible off the kerb with the drive wheels. Don't stop the chair during descent of the kerb. You will feel more secure if you can lean backwards, but if you can't, don't worry, the wheelchair is stable. As long as you stay within its limitation, you will be quite safe.

All powered seating options need to be in home position. Your powered leg rests may need to be adjusted to give enough clearance to mount or dismount the kerb.

We recommend to use the lap strap to feel more secure during declining the kerb.

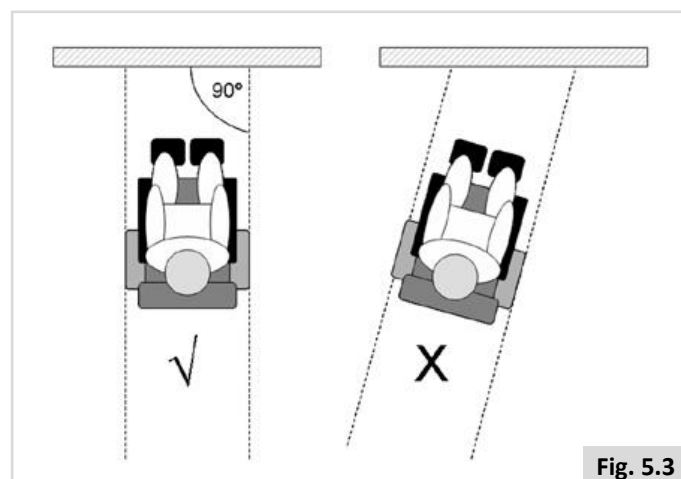

Fig. 5.3

## 5.9 Pushing the wheelchair

The motors must be disengaged using the freewheel lever, in order to push the wheelchair. This feature was developed for the attendants of wheelchair users and also functions as an emergency freewheel lever.

The freewheel lever has 2 positions:

### 1. For driving the wheelchair.

**'Drive'** position: Turn the lever so that the lever at the drive wheel side is positioned as shown in Fig. 5.4.

### 2. For disengaging the motors.

**'Freewheel'** position: Turn the lever so that the lever at the drive wheel side is positioned as shown in Fig. 5.5.

### DANGER!

- The free wheel lever should only be operated by the attendant and never by the user.
- A user may never be left unattended while the wheelchair is in 'freewheel'.
- Never set the lever to the 'freewheel' position on a slope! When the lever is set to 'freewheel', the automatic parking brake is deactivated. This makes it possible for the wheelchair to roll down the slope (Fig. 5.5).
- The automatic parking brake only works if the lever is set to 'drive' position.
- When the wheelchair is no longer being pushed, the lever should be set to 'drive' immediately.
- To manually push the system you must release the motor brakes.
- There are specific labels located on the motors describing this process (Fig. 5.6).
- Do not engage or disengage motor brakes unless power to the system is off.
- Make sure you have full control over the system when you release the motor brakes.
- Make sure the system is on level ground before you release the motor brakes.
- Propel this system by the push handles only. They provide secure points for you to hold the rear of the system to prevent a fall or tip-over.



Fig. 5.4



Fig. 5.5

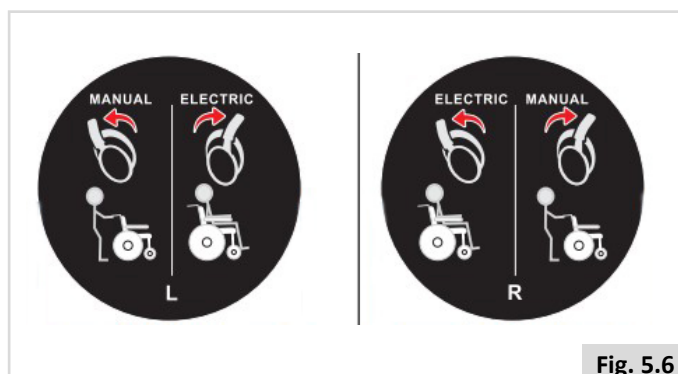

Fig. 5.6

## 6.0 Batteries, charging and range

### 6.1 Usage of Battery

Fully charge the new battery prior to its initial use. This brings the battery up to 90% of its peak performance level. Give the battery a full charge (The green LED on the charger lights) after every use and operate your wheelchair again, the batteries will perform at over 90% of their potential. After four or five charging cycles, the battery utilization rate is close to 100%, extending the battery lifespan.

After battery failure, please be sure to buy new batteries and replace them as required, and the old ones must be returned to the supplier for disposal to prevent environmental pollution.

In the case of not using, it is recommended to charge the battery every two weeks, and use it for more than 20 minutes, which can extend the life of the battery.

It is forbidden to charge outdoors, and pay attention to keep away from fire and heat source when charging. Please put the product in the open, clean, dry and ventilated place with no flammable, explosive or chemical substances around. Batteries replaced or scrapped shall be recovered and disposed of in accordance with local laws.

(Fig.6.1 shows reference to the electrical diagram of the Q50 R Carbon)

### 6.2 Usage of Charger

The battery charger is an important component of wheelchair. The wheelchair can reach full charge by simple and fast charging.

Use charger to charge the battery:

- Make sure the controller is turned off and the rechargeable battery is connected to the controller.
- Connect the three-pin metal plug of the charger to the three-hole interface of the controller
- Plug the other end plug of charger into a standard socket. The blue light is on when charging and the green light is on when the battery is fully charged.
- After battery is fully charged, remove the power line and charger.

#### DANGER!

- Do not, under any circumstances, tamper with the batteries. If in any doubt contact your local Sunrise Medical authorised dealer.
- Do not leave the batteries/battery pack unattended while charging.

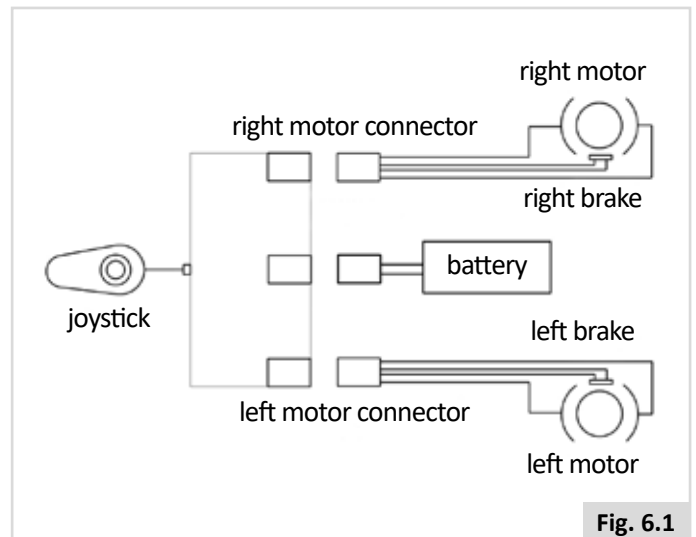

Fig. 6.1

### 6.3 Charging batteries:

The general procedures and effects for the interference with the chair and the batteries remain valid.

#### Battery care plan

Below is set out a battery care plan for maintenance free batteries. This has been agreed with the battery manufacturers, to enable you to get the best out of your batteries. If a different care plan is followed, this may result in lower than expected performance from your mobility vehicle.

- Only use the approved charger compatible with the wheelchair to be charged.
- Charge your batteries every night, regardless of the amount of use your mobility device has had during the day.
- Charge the batteries in a well ventilated area.
- Do not interrupt the charging cycle.
- If your mobility device is not required for use, it should remain connected to the charger until required. This will not damage your batteries, as long as the mains socket/plug is left switched on. Turning the mains socket/plug off, but leaving the mains cable plugged in will eventually deplete your battery charge.
- If you leave your vehicle for an extended period (more than 15 days) charge the battery fully and then disconnect the main battery lead.
- Failure to allow for recharge will damage the batteries and can lead to shortened distances and premature failure.
- Do not top up the charge of your batteries during the day. Wait until the evening for a full overnight charge.
- Following all the points above should result in a healthier battery, greater range for the vehicle user and a longer life for your batteries.

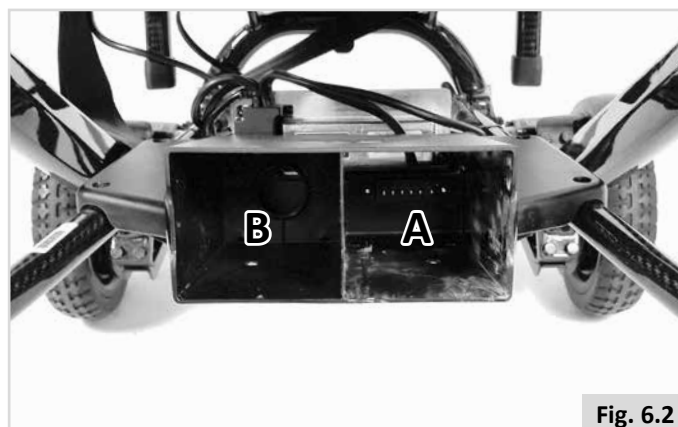

Fig. 6.2

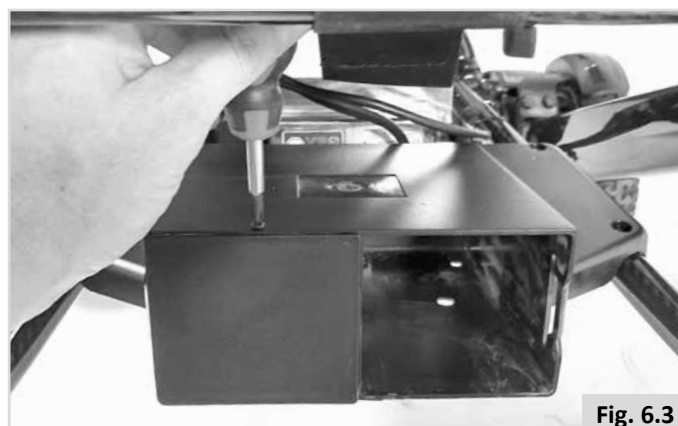

Fig. 6.3

#### Charging Methods

Connect the input plug of charger to the standard power outlet and connect the output plug of charger to the controller socket for charging, or detach the battery for charging by connecting interface on the battery box.

#### WARNING!

Please do not operate the wheelchair while charging.

#### Back up battery

A second battery can be purchased for back up power supply - it can be stored on board the chair. Description of two batteries of the wheelchair: As shown in Figure 6.2 & 6.3, the area in which there is an output interface is called area A; The other area with no output interface is called area B. The battery installed in area A is used for power supply, while the battery installed in area B is only a backup battery. To use the back up battery please unscrew 2 screws located on the battery box using a small crosshead screwdriver, then the cover can be removed (Fig. 6.3).



## Battery Charger

The external charger has been designed to charge the Li-Ion battery (= 24 V).

The chargers have features which prevent hazards or accidents occurring as a result of connecting batteries the wrong way round, overheating caused by fault conditions or attempting to charge wrong voltage batteries. The majority of charger sizes are electrically double insulated and no earth connection is required. Some larger sizes may be electrically earthed and this will be clearly stated on the label.

If your charger has been specified for use in Continental Europe it will contain a European two pin plug which does not have a fuse. In this case the fuse is located in the fascia panel of the charger.

### Country specific information: UK

The 3 pin UK mains input plug contains a replaceable fuse. The rating of this fuse is shown on the charger label.

#### DANGER!

- As with all mains powered electrical equipment, always replace blown fuses with the same type and size of fuse as specified.
- Fitting of different fuses can result in an increased fire risk, damage to the charger or failure of the charger to operate properly.

### Battery Replacement

#### WARNING!

Please replace with battery of same type. Please select the battery type and capacity per specification in the manual. Please use the replacement battery directly provided by the authorized supplier(s) to ensure the performance and function.

#### WARNING!

Please protect the battery from freezing; Please keep the wheelchair in a suitable environment. Please do not charge the frozen battery, otherwise the battery may be damaged.

### Overload / undervoltage fuse

This unit is designed for wheelchair safety by switching off and on a protective circuit within the Lithium-ion battery. It will immediately cut off power supply if the motor is overloaded or the voltage is too low so as to protect motors and electrical components from damage. To restore the fuse function, use the charger to charge the wheelchair or replug the battery connector. (Fig. 6.4)



Fig. 6.4

## 6.4 The range of your vehicle:

Please refer to the specification tables at the back of this manual for Energy Consumption, (Maximum Range), information.

Most manufacturers of mobility products state the range of their vehicles either in the sales literature or within the Owner's Manual. The range stated sometimes differs from manufacturer to manufacturer even though the battery size is the same. But variances still occur due to motor efficiencies and overall product load weight.

The range figures are calculated to I.S.O. Standard 7176. Part 4: Wheelchair Energy Consumption Theoretical Range.

This test is carried out in controlled conditions with new, fully charged batteries, on a level test surface and a user weight of 100 kg. The range figures stated should be seen as a theoretical maximum and could be reduced if any single, or combination, of the following circumstances occur:

- User weight heavier than 100 kg.
- Batteries whose age and condition are less than perfect.
- The terrain is difficult e.g. very hilly, sloping, muddy ground, gravel, grass, snow and ice.
- The vehicle climbs kerbs regularly.
- The ambient temperature is very hot or very cold.
- Lots of start/stop driving.
- Also thick pile carpets within the home can affect range.
- Use of additional power consumption options (e.g. light, actuators, etc.)

The battery sizes available on your product should give sufficient range to cope with the majority of customer's lifestyles.

## 6.5 Battery warranty:

Battery warranties are subject to periods set by the manufacturers. However, most of these warranties are subject to a wear and tear clause, and if you genuinely wear out your batteries in 6 months, it will not be possible to obtain a replacement under warranty.

## 6.6 Replacing batteries

- The wheelchair uses a 24V Li-Ion battery which is fully sealed and require no maintenance.
- Replacing and servicing batteries is to be done by qualified specialist.
- In case of malfunctioning batteries, contact your local dealer.



- Do not attempt to replace or service batteries without the supervision of trained and qualified personnel.

## 6.7 Air Transportation of the wheelchair

The wheelchair and the single 24v Li-Ion battery has air transport certification to the International Air Transport Association (IATA) regulations.

Individual airlines have differing requirements relative to transport of products with Li-Ion batteries. Prior to arranging any air travel with the wheelchair, please confirm with your airline or carrier that they accept battery-powered vehicles under UN classification: UN3171. Note: The pilot of the aircraft has the ultimate decision to allow or deny travel of any device onboard the plane.

If your airline accepts the UN3171 classification, the following steps will be necessary to prepare your wheelchair for air travel.

- The battery must have a maximum charge of 30%. We recommend to completely discharge your battery until the gauge shows the single red LED in the battery display reference Fig 5.1 – item 2 (on page 18).
- Disconnect the battery from compartment 'A' in Fig 6.2 (on page 24), and store the discharged battery in the spare battery compartment 'B'.
- Ensure the battery is correctly clipped into place, and the latch is in place.
- Carefully pack your wheelchair in the original packaging for transport to the airport.

## 6.8 Disconnecting batteries for air transport.

### DANGER!

When reinserting the battery, make sure that the battery fixing clip has latched on to the battery to prevent the battery coming loose. Pull the fixing clip up, then slide the battery to the bottom of the compartment, then release fixing clip ensuring it is catching the feature on the housing. (Fig. 6.8)

## 6.9 Transportation in vehicles:

This wheelchair is not suitable to use as a seat in a vehicle.



**Not crash tested (location can be seen in Fig. 6.5 - 6.7)**



Fig. 6.5

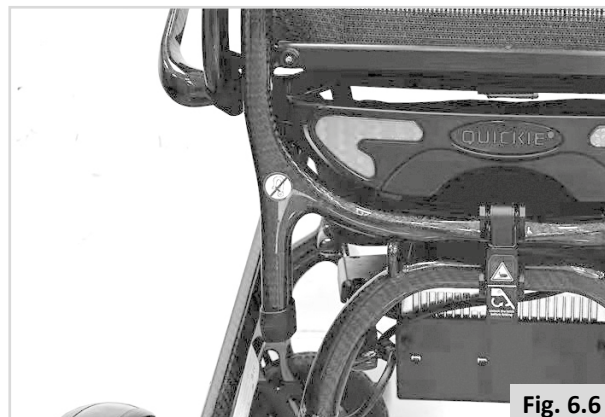

Fig. 6.6



Fig. 6.7



Fig. 6.8

## 6.10 Special transport requirements

### Using your wheelchair on the train.

Before you travel, please contact the train operator. They will be able to supply details of any special requirements/instructions.

We advise you to check the following:

- Is there a suitable and intended “wheelchair” area in the train for wheelchair users (with adequate turning space to manoeuvre)?
- Is there a suitable or designated area on the platform for wheelchair users (with adequate turning space to manoeuvre)?
- Is there suitable boarding access available to allow you to access the railway carriage and the intended “wheelchair” area?
- Is the boarding access suitable for the combined mass of the wheelchair and the occupant?
- Make sure the slope of the boarding access is not greater than the dynamic safe slope. (See Section 10)
- Any obstacles or thresholds should not exceed the max kerb climbing capability of your wheelchair. (See Section 10)

Most train operators will provide assistance provided that arrangements have been made in advance. We suggest you have you Owner’s Manual ready when planning your journey and contacted them.

### Transporting the wheelchair as luggage.

Parts of the wheelchair that can easily be detached should be removed when transporting the wheelchair. Store these parts securely.

- Ensure that any detachable parts are secured with your mobility aid or separately packed and labelled so they do not get lost during loading and unloading.
- The wheelchair may be transported by road, rail, sea or air as the batteries supplied conform to IATA regulations. If the batteries are replaced by non-IATA approved batteries then they will need to be removed for air travel. Your dealer can assist in supplying batteries that are IATA approved.
- Before you travel, please contact the appropriate carrier. The travel operator will be able to supply details of any special requirements/instructions.
- For information about dimensions and weight of the wheelchair, see (Section 10).
- For information about the batteries in your wheelchair see (Section 6).
- Transporting the chair, (Section 6.7).
- Medium to long term storage, follow the instructions, (Section 8.6).

## 6.11 General transport warnings



### WARNING!

- No changes or replacements must be made to the anchorage points/car fastenings on the wheelchair, or to constructional elements or parts of the frame.
- The wheelchair should be inspected by a Sunrise Medical authorised dealer/service agent, before reuse following involvement in any type of vehicle collision.

## 7.0 Fault analysis and troubleshooting

For your convenience, this wheelchair is equipped with an automatic fault warning device. Once it is out of order, the controller panel will display the pattern and the horn will sound. You can find where the fault is according to the table below. If the fault persists after checking, please contact your service agent.

<b>1 Flash</b>	The batteries need charging or there is a bad connection to the batteries.	Check the connections to the batteries. If the connections are good, try charging the batteries.
<b>2 Flashes</b>	The left motor (M1) or encoder has a bad connection.	Check the connections to the left motor and encoder.
<b>3 Flashes</b>	The left motor (M1) wiring is faulty or a stall condition has been detected.	Check the connections to the left motor and encoder.
<b>4 Flashes</b>	The right motor (M2) or encoder has a bad connection.	Check the connections to the right motor and encoder.
<b>5 Flashes</b>	The right motor (M2) wiring is faulty or a stall condition has been detected.	Check the connections to the right motor and encoder.
<b>7 Flashes</b>	A joystick fault is indicated.	Make sure that the joystick is in the center position before switching on the controller.
<b>7 Flashes (+ flashing speed indicator)</b>	A communication fault is indicated.	Make sure that the joystick module cable is securely connected and not damaged.
<b>8 Flashes</b>	A possible controller fault is indicated.	Make sure that all connections are secure.
<b>9 Flashes</b>	The parking brakes have a bad connection.	Check the parking brake, motor and controller connections are all secure.
<b>10 Flashes</b>	An excessive voltage has been applied to the controller. This is usually caused by a poor battery connection.	Check the battery connections are all secure.

## 8.0 Maintenance & cleaning

The wheelchair's lifespan is dependent on it being well maintained.

For information concerning specific settings, maintenance or repair work, please contact your authorised Sunrise dealer. Always be sure to mention the model, year of manufacture and identification number provided on the identification plate of the wheelchair when contacting your dealer.

### ⚠ CAUTION!

The wheelchair should be serviced by your authorized Sunrise dealer once a year or, in the case of intensive use, every six months. For a list of approved authorised dealers in your area please contact Sunrise Medical Service Centre. The contact details of your local Sunrise medical service centre can be found on the inside front cover of this booklet. National and International Website addresses are on the back cover.

## 8.1 Maintenance

### ⚠ WARNING!

- Loose fasteners should be re-tightened according to the installation instructions. Please refer (unless otherwise specified) to the general table below for needed Torques (Fig. 8.1).
- Chest straps should be replaced at the first indication of damage and/or excessive wear.
- If a broken or loose component is found, discontinue use immediately and contact your authorised Sunrise Medical supplier for replacement.
- Check all Velcro fastening straps for correct adhesion when pressed together.
- Ensure that any contamination, such as fluff, hair, etc is removed from the Velcro straps. Such contamination may affect adhesion.

### ⚠ WARNING!

- If you are in any doubt about the performance requirements of your wheelchair contact your Sunrise Medical authorised dealer.
- After performing any maintenance or repairs on the wheelchair you must make sure that it is functioning correctly before it is used.
- All fasteners must be replaced like for like using the correct length, tensile strength and materials.
- When replacing self-locking nuts, or nuts/studs secured with a thread locking solution, ensure that a suitable thread locking solution is reapplied to the fastener.

### Daily checks

Perform the daily check routine before driving as described in chapter 5.1

### Weekly checks

Perform the weekly check routine before driving as described below.

#### Checking Parking brake:

This test should be carried out on a level floor with at least one meter clearance all around the chair.

- Switch on the control system.
- Check that the battery gauge remains on, or flashes slowly, after one second.
- Push the joystick slowly forwards until you hear the parking brakes operate.
- The chair may start to move.
- Immediately release the joystick. You must be able to hear each parking brake operate, (click), within a few seconds.
- Repeat the test a further 3 times, pushing the joystick slowly backwards, left and right.

#### Checking connectors & cables:

- Make sure that all connectors are securely mated.
- Check all cables are not loose and secured to the chair.
- Check the condition of all cables and connectors for damage.

Fig. 8.1

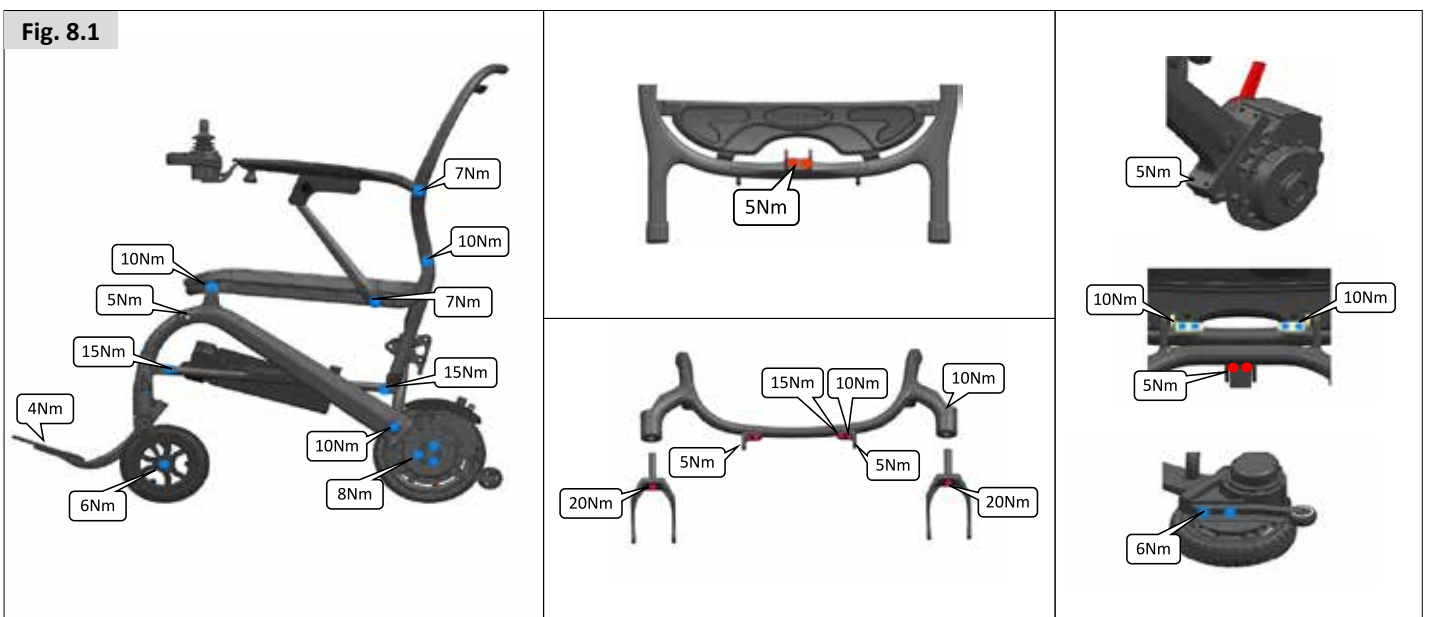

### Checking controller:

- Check the thin rubber gaiter or boot around the base of the joystick shaft for damage or splitting. Check visually only, do not handle the gaiter.
- Make sure that all components of the control system are securely mounted. Do not over-tighten any securing screws.

### Checking controls:

- Switch on the hand control – Do the lights flash? This signifies that there is a fault in the electronic system. Refer to chapter 9 for basic troubleshooting
- Operate all of the electric options, including lights and indicators, (if fitted), to make sure that they work correctly.
- With the seating in an elevated position, drive the wheelchair to make sure that the 'creep' mode works which will slow the wheelchair.
- Drive the wheelchair in each of the drive profiles to make sure the wheelchair performs as it did before.

### WARNING!

- If you are in any doubt about the performance requirements of your wheelchair contact your Sunrise Medical authorised dealer.
- After performing any maintenance or repairs on the wheelchair you must make sure that it is functioning correctly before it is used.
- A complete inspection, safety check and service should be made by a Sunrise Medical authorised dealer at least once per year.
- All fasteners must be replaced like for like using the correct length, tensile strength and materials.
- When replacing self-locking nuts, or nuts/studs secured with a thread locking solution, ensure that a suitable thread locking solution is reapplied to the fastener.
- Check all Velcro fastening straps for correct adhesion when pressed together.
- Ensure that any contamination, such as fluff, hair, etc is removed from the Velcro straps. Such contamination may affect adhesion.

### Monthly checks

Perform the monthly check routine before driving as described below.

- All fasteners should be checked monthly for wear, such as loose bolts or broken components.
- Check all straps monthly for fraying, ripped seams or other indications of excessive wear damage. Discontinue use if damage is found.

## 8.2 Tyre maintenance and pressures

### 8.2.1 Tyre wear

When inspecting the tyres for signs of wear, look for significant scuff marks, cuts and a diminished tyre tread. Wheels will need to be changed when the tread cannot be seen over the complete surface of the tyre, (Fig.8.2).



## 8.2.2 Drive wheel repair

### To remove the drive wheel: (Fig. 8.3 & 8.4)

- Remove the colour insert off the drive wheel.
- Using 2 x 4mm Hex keys, unscrew and remove 3 bolts from the drive wheel.
- Remove drive wheel from the wheelchair..

**Note:** Reverse the process to put the wheel back on. (Tighten bolts to 8Nm).

### To remove the front castor wheel: (Fig. 8.5)

- Using 2 x 4mm Hex keys, unscrew and remove the central bolt from the castor wheel.
- Remove castor wheel from the wheelchair.

**Note:** Reverse the process to put the wheel back on. (Tighten bolt to 6Nm).

**Note:** Transfer colour insert over if needed to new wheel.

### To remove the anti-tip wheel: (Fig. 8.6)

- Using 2 x 4mm Hex keys, unscrew and remove the central bolt from the anti tip wheel.
- Remove anti tip wheel from the wheelchair.

**Note:** Reverse the process to put the wheel back on. (Tighten bolt to 4-5Nm).



Fig. 8.3



Fig. 8.4



Fig. 8.5



Fig. 8.6



<b>Maintenance &amp; Inspection Schedule</b>	Daily*	Weekly	Monthly	Annually
Daily check routine as described in chapter 5.1	*			
Weekly check routine as described in chapter 8.1		*		
<b>Complete inspection, safety check and service should be made by a Sunrise Medical authorised dealer.</b>				*

### 8.3 Wheels & tyres maintenance

When inspecting the tyres for signs of wear, look for significant scuff marks, cuts and a diminished tyre tread. Tyres will need to be changed when the tread cannot be seen over the complete surface of the tyre.

Castor wheel	Max. tyre pressure
6.5" (165mm)	Solid tyre only
Drive wheel	Max. tyre pressure
8.3" (210mm)	Solid tyre only

## 8.4 Cleaning and disinfection

The wheelchair should be wiped over once per week with a slightly damp, not wet, cloth and any fluff or dust that has accumulated around the motors should be blown or dusted away.

### CAUTION!

Make sure that you dry all parts of your wheelchair if it becomes wet or damp after cleaning or if it is used in a wet or damp atmosphere.

### DANGER!

It is important that should the wheelchair be used by more than one person it is cleaned thoroughly to ensure there is no cross infection.

### Hygiene measures when being re-used:

Prior to the wheelchair being re-used, it must be carefully prepared. All surfaces which come into contact with the user must be treated with a disinfection spray.

To do this, you must use a disinfectant as authorised/recommended in your country, for rapid alcohol-based disinfection for medical products and medical devices, which must be disinfected quickly.

Please be aware of the manufacturer's instructions for the disinfectant you are using.

In general, a complete disinfection cannot be guaranteed on seams. We therefore recommend that you dispose of seat and back slings to avoid micro-bacterial contamination with active agents according to your local infection protection law.

### CAUTION!

- Do not use solvents, bleaches, abrasives, synthetic detergents, wax polishes or aerosols.
- Disinfectants may be used in dilution as specified by their manufacturer.
- Ensure surfaces are rinsed with clean water and dried thoroughly.

### WARNING!

- Always read the label on any commercial or domestic cleaning substances.
- Always follow the instructions carefully.

### Cleaning controls:

Should the control of your wheelchair become soiled or dirty, it can be wiped with a damp cloth with a dilute disinfectant until clean.

### DANGER!

Important: If the wheelchair is to be used by more than one person, follow the cleaning and disinfection instructions carefully to ensure that there is no cross infection.

## 8.5 Medium to long term storage:

When storing your wheelchair for long periods of time (in excess of one week), follow these simple instructions:

- Fully charge the wheelchair for at least 24 hours.
- Disconnect the charger.
- Disconnect the batteries.

### WARNING!

Never store your wheelchair:

- Outside.
- In direct sunlight, (plastic parts may discolour).
- Near a source of direct heat.
- In a damp environment.
- In a cold environment.
- With the batteries/battery boxes connected, (even if the controller is switched off).

Avoiding all of the above will minimise battery deep cycle discharge and extend battery lifetime.

When returning the wheelchair to use, please reconnect the batteries/battery boxes and charge the wheelchair for at least 24 hours before use.

Storage Temperature: Min: -40°C Max: 65°C

No restrictions on humidity and air pressure.

## 9.0 Disposal

The symbols below mean that in accordance with local laws and regulations your product should be disposed of separately from household waste. When this product reaches the end of its life, take it to the local collection point designated by local authorities. The separate collection and recycling of your product at the time of disposal will help conserve natural resources and ensure that it is recycled in a manner that protects the environment.

Ensure you are the legal owner of the product prior to arranging for the product disposal in accordance with the above recommendations and national requirements.

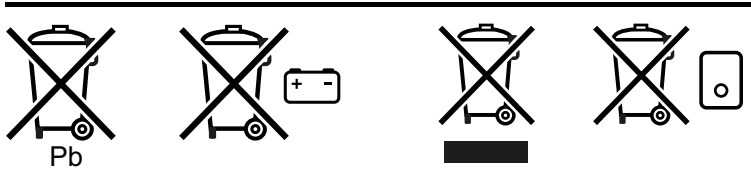

In the following section, there is a description of the materials used on the wheelchair, in view of the disposal or recycling of the wheelchair and its packaging.

There may also be special local regulations in force with regard to disposal or recycling, these must be taken into account when disposing of your wheelchair. (This can include the cleaning or decontamination of the wheelchair prior to disposal).

**Aluminium:** Castor forks, latch

**Steel:** Fasteners

**Plastic/PU:** Castors and wheel/tyre, battery box, mudguard, armrest support

**Packaging:** Plastic bags made of soft polyethylene, cardboard

**Carbon:** Frame, seat plate, footplate, backrest

Disposal or recycling should be done through a licensed agent or authorised place of disposal. Alternatively your wheelchair may be returned to your dealer for disposal.



## 10.0 Trouble shooting

If the wheelchair is not working as it should, check the following points.

- Check whether the batteries are charged.
- Turn the wheelchair off and then back on again.
- Check whether the battery plugs are all securely in place.
- Check whether the freewheel lever is in the DRIVE position
- Make sure that the controller isn't locked

## 11.0 Technical specifications: Applicable norms / standards



This product complies with the regulations and guidelines for medical aids and carries a CE and UKCA symbol. The product meets the requirements and standards below. These are checked by independent institutions.  
EN ISO 10993-5:2009  
Biological evaluation of medical devices - Part 5: Tests for in vitro cytotoxicity (ISO 10993-5:2009)



As the Authorised Representative, SUNGO CERTIFICATION COMPANY LIMITED, declares that the product conforms to the UK Medical Devices Regulation 2002 No. 618.

Standard	Definition / description	Test Dummy Weight
Medical Device Regulation (EU) 2017/745	Applicable as mentioned in Appendix 1	
EN 12182: 2012 Class A	Assistive products for persons with disability - General requirements and test methods	136 kg
	Q50 R Carbon	136 kg
EN 12184: 2022 Class A	Electrically powered wheelchairs, scooters and their chargers - Requirements and test methods	136 kg
	Q50 R Carbon	136 kg
ISO 7176-8: 2014	Requirements and test methods for impact, static and fatigue strengths	N/A
ISO 7176-9: 2009	Climate tests for electric wheelchairs	N/A
ISO 7176-14: 2022	Requirements and test methods for control systems for electric wheelchairs	N/A
ISO 7176-16: 2012	Requirements for resistance to ignition of upholstered parts	N/A

Model	Q50 R series		
Type / configuration <b>Rear wheel drive</b>	<b>Q50 R Carbon</b>		
Maximum user weight			
In combination with Sedeo Lite	136 kg	300 lbs.	
EN12184 class:	A		

Description	Metric system values		Imperial system values & alternative	
	Minimum	Maximum	Minimum	Maximum
Total length (including legrests) Rear wheel drive				
Footplate	923 mm		36.3"	
Total width	570 mm		22.4"	
Total weight Basic configuration with centre mount footrest, no batteries	14.5 kg		32 lbs.	
Total weight influencers Batteries	1.4 kg		3.1 lbs	
Transport weight of the heaviest part	14.5 kg		32 lbs.	
Dynamic stability: Rated slope	6°		10.5 %	
Min. braking distance at maximum speed	1000 mm		39.4"	
Static stability Q50 R Carbon                      Downwards / Upwards / Sideways	9°/9°/9°		15,8%/15,8%/15,8%	
<i>NB: The following aspects have a negative influence on the range of action: Obstacles, rugged terrain, driving on slopes, exposure to temperatures below freezing point and frequent use of powered seat options.</i>				
6 kph range	12 km	24 km	7.2 miles	14.5 miles
Climbing capability for obstacles	40 mm		1.6"	
Max speed forward	6 kph		4 mph	
Turning Radius                      Centre mount footrest	800 mm		31.5"	
Turning space / reversing width Centre mount footrest	1100 mm		43.3"	
Ground Clearance	70 mm		2.75"	

Description	Metric system values		Imperial system values & alternative	
	Minimum	Maximum	Minimum	Maximum
Battery capacity	10 Ah		10 Ah	
Maximum permissible charging voltage	24V		24V	
Maximum charging current	2 A (rms)		2 A (rms)	
Insulation	Class 2 double insulated		Class 2 double insulated	

Description	Metric system values		Imperial system values & alternative	
	Minimum	Maximum	Minimum	Maximum
Seat to floor height	495 mm		19.5"	
Backrest angle	16°			
Back height	464 mm		18.3"	
Armrest				
Armrest pad height (seatplate to top armpad)	190 mm	320 mm	7.5"	12.6"
Armrest pad depth (on armrest profile)	100 mm		3.9"	
Center Mount Legrest				
Lower leg length (from seatplate)	410 mm		16.1"	
Knee angle	118°			

## 12.0 Warranty

### THIS GUARANTEE DOES NOT AFFECT YOUR LEGAL RIGHTS IN ANY WAY.

Sunrise Medical\* (on behalf of the manufacturer) provides a guarantee, as set out in the warranty conditions, for products to its customers covering the following.

#### Warranty conditions:

1. Should a part or parts of the product require repair or replacement as a result of a manufacturing and/or material fault within 24 months, then the affected part or parts will be repaired or replaced free of charge. The warranty will only cover manufacturing defects
2. To enforce the warranty, please contact the supplier of your wheelchair – e.g. the Sunrise Medical Approved dealership or Healthcare provider with the exact details of the nature of the difficulty. Should you be using the product outside the area covered by the Sunrise Medical customer service agent, repairs or replacement will be carried out by another agency as designated by the manufacturer. The product must be repaired by a Sunrise Medical designated Customer Service agent, (dealer).
3. For parts, which have been repaired or exchanged within the scope of this warranty, we provide a warranty in accordance with these warranty conditions for the remaining warranty period for the product in accordance with point 1.
4. For original spare parts which have been fitted at the customer's expense, these will have a 12 months guarantee, (following the fitting), in accordance with these warranty conditions.
5. Claims from this warranty shall not arise, if a repair or replacement of a product or a part is required for the following reasons:
  - a. Normal wear and tear, which include but is not limited to the following parts where fitted; batteries, armrest pads, upholstery, tyres, brakes shoes, ferrules, etc.
  - b. Any overloading of the product, please check the EC label for maximum user weight.
  - c. The product or part has not been maintained or serviced in accordance with the manufacturer's recommendations as shown in the user instructions and/or the service instructions.
  - d. Accessories have been used which are not specified as original accessories.
  - e. The product or part having been damaged by neglect, accident or improper use.
  - f. Changes/modifications have been made to the product or parts, which deviate from the manufacturer's specifications.
  - g. Repairs have been carried out, before our Customer Service has been informed of the circumstances.
6. This guarantee is subject to the law of the country in which the product was purchased from Sunrise Medical"
7. Life expectancy

We estimate a life expectancy of five years for this product, provided that:

  - It is used in strict accordance with the intended use as set out in this document.
  - All maintenance and service requirements are met.

The estimated life expectancy can be exceeded if the product is carefully used and properly maintained, provided that technical and scientific advances do not result in technical limitations.

The life expectancy can also be considerably reduced by extreme or incorrect usage.

















The fact that we estimate a life expectancy for this product does not constitute an additional warranty..

\* Means the Sunrise Medical facility from which the product was purchased.

#### Additional Notes For Australia Only:

- i. For goods distributed by Sunrise Medical Pty Ltd in Australia, our goods come with a guarantee by Sunrise Medical (on behalf of the manufacturer) that cannot be excluded under Australian Consumer Law.
- ii. You are entitled to a replacement or refund for a major failure and for compensation for any foreseeable loss or damage.
- iii. You are also entitled to have the goods repaired or replaced if the goods fail to be of acceptable quality and the failure does not amount to a major failure.
- iv. The benefits to you given by this warranty are in addition to your other rights and remedies under a law in relation to the goods to which the warranty relates.

## 13.0 Nameplate

<b>TYPE:</b>	Product Name/SKU Number.
	Maximum safe slope with anti-tip tubes fitted, Depends on wheelchair setting, posture and physical capabilities of the user.
	Maximum user weight.
	Load Maximum.
	Maximum speed.
	Maximum axle loading.
	UKCA Mark.
	CE Mark.
	Consult instructions for use.
	Indicates electrical / electronic equipment must be disposed of in accordance with the WEEE regulation.
	Date of manufacture.
	Serial number.
	This symbol means Medical Device.
	Manufacturer's address.
	Importer's address
	UK Responsible Person
	Swiss Representative's address

Sunrise Medical S.r.l.  
Via Riva, 20 – Montale  
29122 Piacenza  
Italia  
Tel.: +39 0523 573111  
Fax: +39 0523 570060  
www.SunriseMedical.it

Sunrise Medical AG  
Erlenauweg 17  
CH-3110 Münsingen  
Schweiz/Suisse/Svizzera  
Fon +41 (0)31 958 3838  
Fax +41 (0)31 958 3848  
www.SunriseMedical.ch

Sunrise Medical AS  
Delitoppen 3  
1540 Vestby  
Norge  
Telefon: +47 66 96 38 00  
post@sunrisemedical.no  
www.SunriseMedical.no

Sunrise Medical AB  
Neongatan 5  
431 53 Mölndal  
Sweden  
Tel.: +46 (0)31 748 37 00  
post@sunrisemedical.se  
www.SunriseMedical.se

MEDICCO s.r.o.  
H – Park, Heršpická 1013/11d,  
639 00 Brno  
Czech Republic  
Tel.: (+420) 547 250 955  
Fax: (+420) 547 250 956  
www.medicco.cz  
info@medicco.cz  
Bezplatná linka 800 900 809

Sunrise Medical Aps  
Mårkærvej 5-9  
2630 Taastrup  
Denmark  
+45 70 22 43 49  
info@sunrisemedical.dk  
Sunrisemedical.dk

Sunrise Medical Australia  
11 Daniel Street  
Wetherill Park NSW 2164  
Australia  
Ph: +61 2 9678 6600  
E: enquiries@sunrisemedical.com.au  
www.SunriseMedical.com.au

Sunrise Medical  
North American Headquarters  
2842 Business Park Avenue  
Fresno, CA, 93727, USA  
(800) 333-4000  
(800) 300-7502  
www.SunriseMedical.com

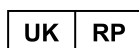

SUNGO Certification  
Company Limited  
3rd Floor  
70 Gracechurch Street  
London  
EC3V 0HR



SUNGO Europe B.V.  
Fascinatio Boulevard 522  
Unit 1.7  
2909VA Capelle aan den  
IJssel  
The Netherlands



Zhejiang Innuovo Rehabilitation  
Devices Co. Ltd  
No. 196 Industry Road  
Hengdian Movie Zone  
Dongyang  
Zhejiang  
China



OM\_Q50R Carbon\_EU\_EN\_  
Rev.C\_2023-11-03

Sunrise Medical GmbH  
Kahlbachring 2-4  
69254 Malsch/Heidelberg  
Deutschland  
Tel.: +49 (0) 7253/980-0  
Fax: +49 (0) 7253/980-222  
www.SunriseMedical.de

Sunrise Medical  
Thorns Road  
Brierley Hill  
West Midlands  
DY5 2LD  
England  
Phone: 0845 605 66 88  
Fax: 0845 605 66 89  
www.SunriseMedical.co.uk

Sunrise Medical S.L.  
Polígono Bakiola, 41  
48498 Arrankudiaga – Vizcaya  
España  
Tel.: +34 (0) 902142434  
Fax: +34 (0) 946481575  
www.SunriseMedical.es

Sunrise Medical Poland  
Sp. z o.o.  
ul. Elektronowa 6,  
94-103 Łódź  
Polska  
Telefon: + 48 42 275 83 38  
Fax: + 48 42 209 35 23  
E-mail: pl@sunrisemedical.de  
www.Sunrise-Medical.pl

Sunrise Medical B.V.  
Groningenhaven 18-20  
3433 PE NIEUWEGEIN  
The Netherlands  
T: +31 (0)30 – 60 82 100  
F: +31 (0)30 – 60 55 880  
E: info@sunrisemedical.nl  
www.SunriseMedical.nl

Sunrise Medical HCM B.V.  
Vossenbeemd 104  
5705 CL Helmond  
The Netherlands  
T: +31 (0)492 593 888  
E: customerservice@sunrisemedical.nl  
www.SunriseMedical.nl  
www.SunriseMedical.eu  
(International)

Sunrise Medical SAS  
ZAC de la Vrillonnerie  
17 Rue Michaël Faraday  
37170 Chambray-Lès-Tours  
Tel : +33 (0) 2 47 55 44 00  
Email: info@sunrisemedical.fr  
www.sunrisemedical.fr

Sunrise Medical Canada Inc.  
237 Romina Drive, Unit 3  
Concord, ON  
Canada L4K 4V3  
Phone: 800.263.3390  
Fax: 800.561.5834  
E-mail: cscanada@sunmed.com  
www.SunriseMedical.ca